

Virtual Battery for Real-time co-Simulations

Sendyne CellMod™ FMU is a Li-Ion battery Functional Mockup Unit. It contains an Electrochemical model of the Panasonic NCR18650A cell and the dtSolve™ model solver. It will interface through the FMI standard to any supporting simulation platform for co-simulation. The CellMod™ FMU accepts as input Current, Ambient Temperature, and time-step and will output Voltage, Cell Internal Temperature, SOC and any other cell internal state variable.

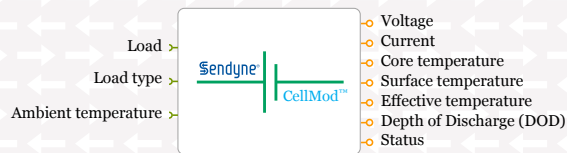

Accurate Determination of Cell Runtime

Sendyne CellMod™ FMU takes into account physical processes taking place inside the cells, such as diffusion in solids, diffusion in electrolytic solution, reaction kinetics, charge transport, heat transport, etc. Because of this, CellMod can predict future battery cell behavior with better than 95% accuracy in all validation tests.

Error of model in runtime prediction in 18 different experiments

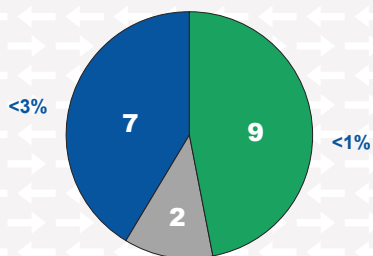

Error in each group of experiments. Number of experiments shown inside the circle

Faster than Real-time

Sendyne CellMod™ FMU comes with Sendyne's proprietary dtSolve™, a model solver proven capable of executing several orders of magnitude faster than other commercially available numerical solvers.

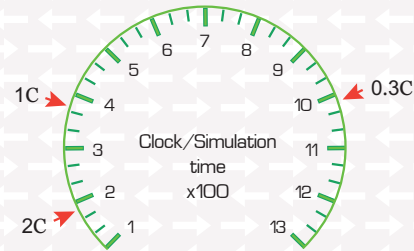

Speed of simulation time compared with real time for various loads.

Scalable Output And Virtual Conditioning Of The Cell

Sendyne CellMod™ FMU can be configured to simulate any parallel and serial combination of similar cells to match the battery requirements of the target system simulation. In addition cells can be pre-conditioned for capacity loss and internal impedance buildup to simulate an aged cell.

Quick Customization of Any Type of Cell

Sendyne CellMod™ FMU can be quickly adapted to represent any type of Li-Ion cells, from NMC and LMO to LFP and NCA, and all iterations of these cells. To achieve this, only a simple (non-proprietary) set of experimental data on the cell to be modeled is needed. Sendyne's tool kit, which includes state of the art parameter extraction, then creates a unique CellMod version for a specific cell. All unique CellMod™ versions are created under NDA.

Sendyne®

Sendyne Modeling Family

CellMod™ FMU

LiIon Cell

Functional Mockup Unit for co-Simulation

Sendyne® CellMod is based on John Newman's pseudo-2D electrochemical model

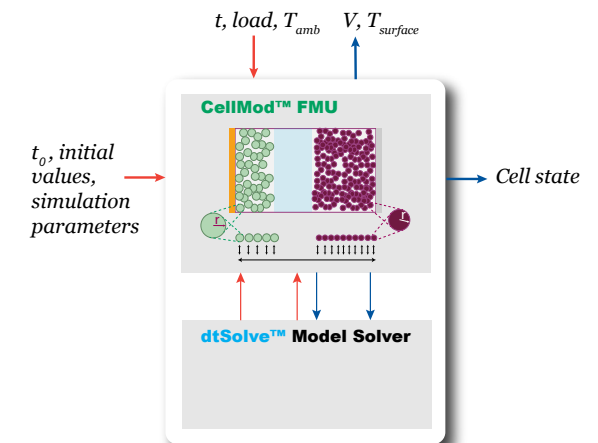

Sendyne CellMod™ FMU

For Energy & Power Control Function Development

Sendyne CellMod™ FMU will interface through FMI to any FMI enabled simulation platform to provide the essential inputs for evaluating performance and developing power and thermal management functions.

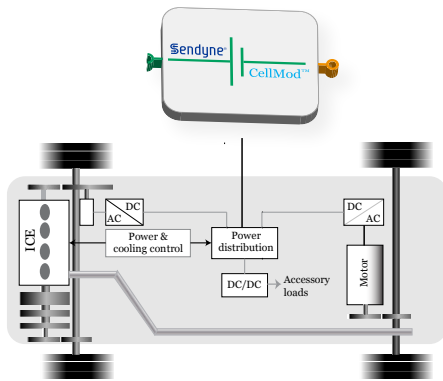

Sendyne CellMod™ FMU

For Hardware and Software in the Loop

Sendyne CellMod™ FMU Virtual Battery can provide the more realistic battery inputs to software and hardware in the loop applications.

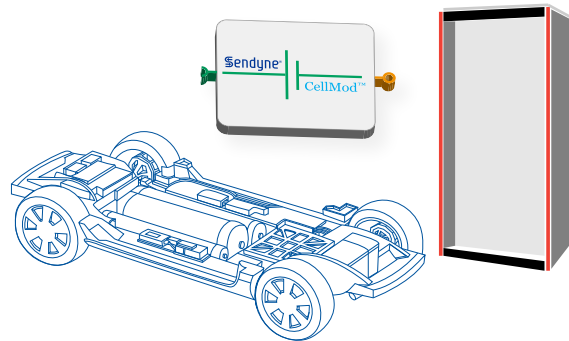

Sendyne CellMod™ FMU

For Pack Thermal Simulation

Sendyne CellMod™ FMU Virtual Battery will interface with CFD software for pack thermal design. In addition it will provide a real time pack power, energy and thermal simulation for cooling control development..

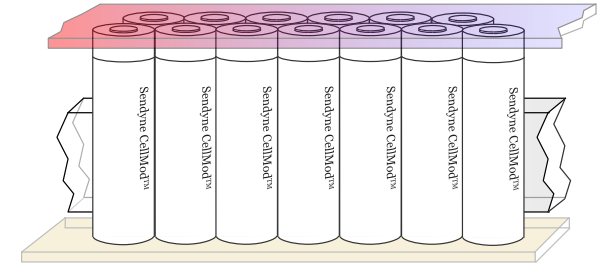

Sendyne CellMod™ FMU

For Cell Selection and Accelerated Testing

The accuracy of CellMod™ FMU enables accelerated cell testing and selection by comparing FMUs optimized for individual cells in various load and environmental conditions

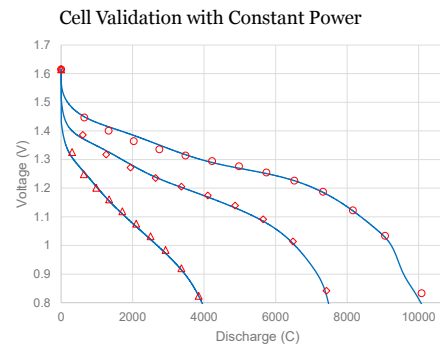

Sendyne CellMod™ FMU

For Online Battery Prediction

The speed, small code size and the memory management features of CellMod™ FMU enable its utilization in embedded applications.

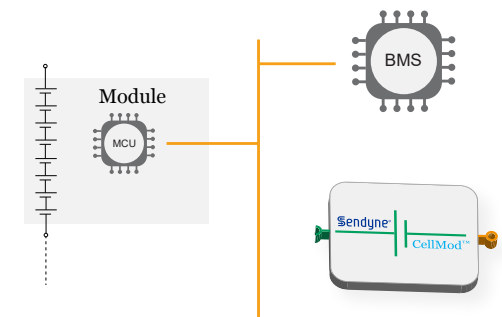

Contact

Sendyne Corp.
250 West Broadway
New York, NY 10013
info@sendyne.com
www.sendyne.com